

MOEN®

ORDER BY PART NUMBER

VALVE TRIM ONLY

UT2901
UT2901BN
UT2901BL

SHOWER TRIM ONLY

UT2902EP
UT2902EPBN
UT2902EPBL
UT2902NH
UT2902NHBN
UT2902NHBL

TUB SHOWER TRIM

UT2903EP
UT2903EPBN
UT2903EPBL
UT2903NH
UT2903NHBN
UT2903NHBL

FINISH

Chrome
Brushed Nickel
Matte Black
Chrome
Brushed Nickel
Matte Black

*All models with an EP suffix include a 1.75 GPM showerhead

**All models with an NH suffix do not include a showerhead

Illustrated Parts

GIBSON™

Single-Handle M-CORE™ 2-Series Trim

ID	Kit Description	Kit Number	Finish
A	Shower Arm Flange	137488	Chrome
		137488BN	Brushed Nickel
		137488BL	Matte Black
B	Shower Arm (Showerhead EP)	10154	Chrome
		10154BN	Brushed Nickel
		10154BL	Matte Black
C	Shower Head (1.75 GPM)	6399EP	Chrome
		6399EPBN	Brushed Nickel
		6399EPBL	Matte Black
D	Cartridge Assembly	1212	N/A
E	Cartridge Nut	200762	N/A
F	Sleeve	200775	Chrome
		200775BN	Brushed Nickel
		200775BL	Matte Black
G	Backing Plate	200766	N/A
H	Snap Ring	200772	N/A
I	Backing Plate Screws (2)	200764	N/A
J	Escutcheon Kit	206320	Chrome
		206320BN	Brushed Nickel
		206320BL	Matte Black
K	Set Screw (Requires 3/32" Hex Key)	40057	N/A
L	Handle Kit	206321	Chrome
		206321BN	Brushed Nickel
		206321BL	Matte Black
M	Diverter Tub Spout	3890	Chrome
		3890BN	Brushed Nickel
		3890BL	Matte Black

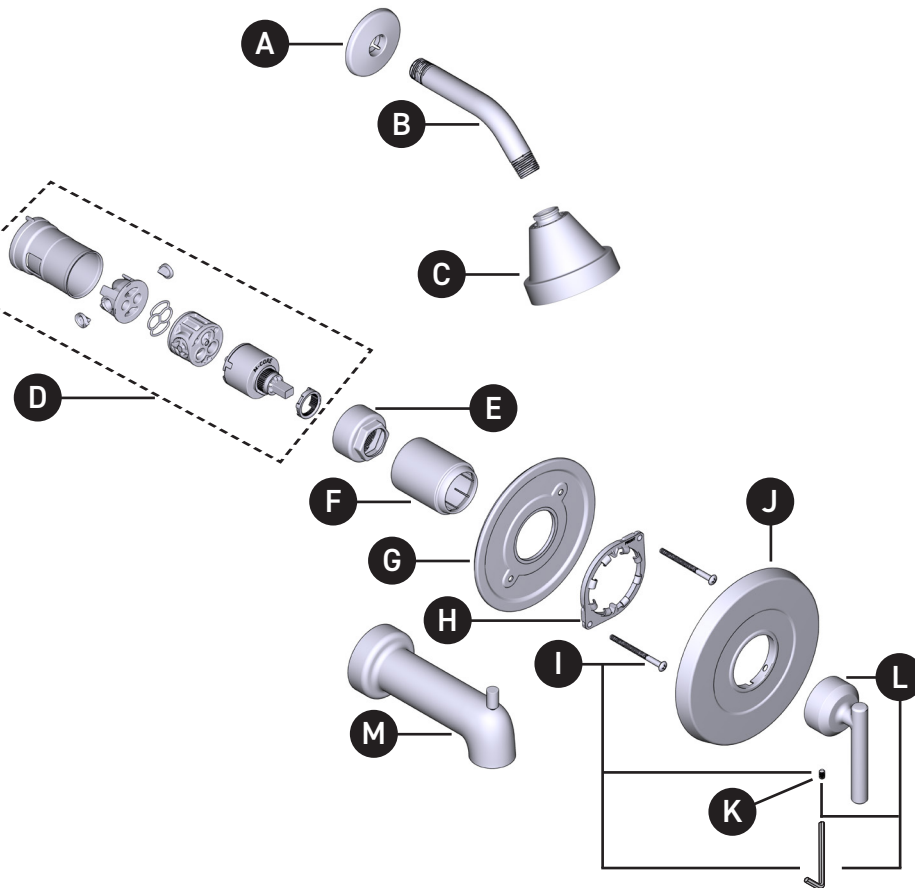

OPTIONAL: 1" Handle Extension Kit

MODEL	FINISH
200755	Chrome
200755BN	Brushed Nickel
200755BG	Matte Black

