

Single Phase Duplex

AE21L=3, AE21H=3, AE21L=4, AE21H=4

AE24L=3, AE24H=3, AE24L=4, and AE24H=4

Manufactured by SJE-Rhombus®

Installation Instructions and Operation/Troubleshooting Manual



7000 Apple Tree Avenue
Bergen, New York 14416
Phone: 1-800-543-2550
Email: liberty@libertypumps.com
www.libertypumps.com

This control panel must be installed and serviced by a licensed electrician in accordance with the National Electric Code NFPA-70, state and local electrical codes.

All conduit running from the sump or tank to the control panel must be sealed with conduit sealant to prevent moisture or gases from entering the panel. **NEMA 1 enclosures are for indoor use only**, primarily to provide a degree of protection against contact with enclosed equipment. Cable connectors are not required to be liquid-tight in NEMA 1 enclosures. **Do not use NEMA 1 enclosures if subjected to rain, splashing water or hose-directed water.** **NEMA 4X enclosures are for indoor or outdoor use**, primarily to provide a degree of protection against corrosion, windblown dust and rain, splashing water and hose-directed water. **Cable connectors must be liquid-tight in NEMA 4X enclosures.**

 WARNING	ELECTRICAL SHOCK HAZARD Disconnect power before installing or servicing this product. A qualified service person must install and service this product according to applicable electrical and plumbing codes.	 WARNING	EXPLOSION OR FIRE HAZARD Do not use this product with flammable liquids Do not install in hazardous locations as defined by National Electrical Code, ANSI/NFPA 70.
Failure to follow these precautions could result in serious injury or death. Replace product immediately if switch cable becomes damaged or severed. Keep these instructions with warranty after installation. This product must be installed in accordance with National Electric Code, ANSI/NFPA 70 so as to prevent moisture from entering or accumulating within boxes, conduit bodies, fittings, float housing, or cable.			

Warranty void if panel is modified.

Call factory with servicing questions:

1-800-543-2550

Installation Instructions

Most single phase duplex panels are designed to operate as three or four float systems. The three float system is standard performing the common pump stop, lead pump start, and lag pump start/high level alarm functions. The four float system utilizes separate floats for lag pump start and high level alarm.

NOTE: Options ordered may affect the number of floats and their functions. Please reference the schematic provided with the control panel for proper installation.

Installation of Floats

CAUTION: If control switch cables are not wired and mounted in the correct location, the pump system will not function properly.

WARNING: Turn off all power before installing floats in pump chamber. Failure to do so could result in serious or fatal electrical shock.

1. Use float label kit to identify and label cables on both float and stripped ends (stop, lead, lag, alarm, etc.). See schematic for float options.
2. Determine your normal operating level, as illustrated in **Figures 1-2**.
3. Mount float switches at appropriate levels as illustrated in **Figures 3-5**. Be sure that floats have free range of motion without touching each other, or other equipment in the basin.

If using the mounting clamp; follow steps 4-6.

4. Place the cord into the clamp as shown in **Figure 5**.
5. Locate the clamp at the desired activation level and secure the clamp to the discharge pipe as shown in **Figure 5**.

NOTE: Do not install cord under hose clamp.

6. Tighten the hose clamp using a screwdriver. Over tightening may result in damage to the plastic clamp. Make sure the float cable is not allowed to touch the excess hose clamp band during operation.

NOTE: All hose clamp components are made of 18-8 stainless steel material. See your SJE-Rhombus® supplier for replacements.

FIGURE 1: Three float duplex

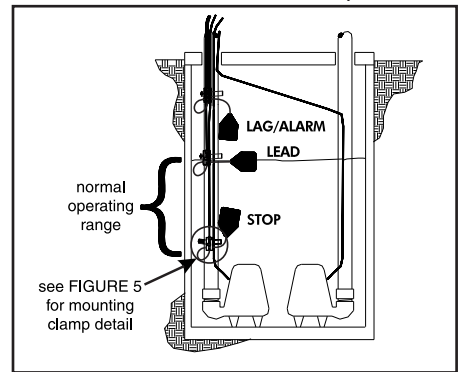

FIGURE 2: Four float duplex

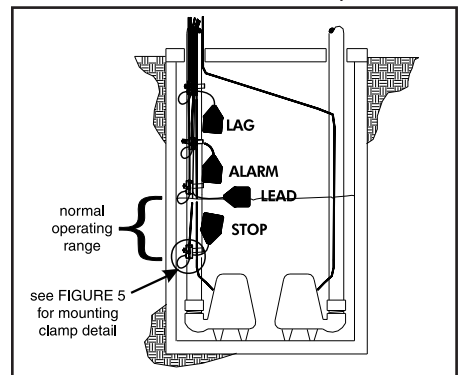

FIGURE 3: Internally weighted float

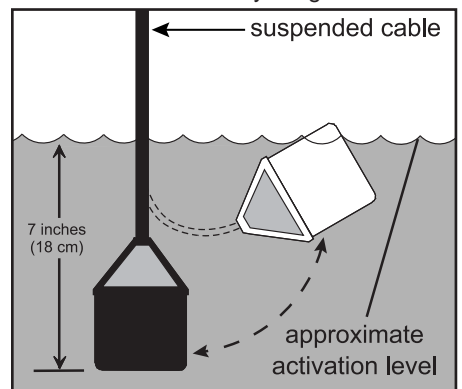

FIGURE 4: Float with cable weight

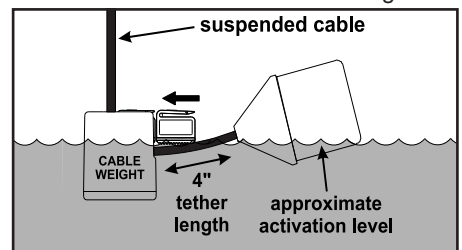
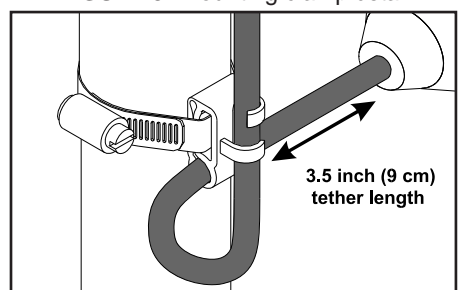

FIGURE 5: Mounting clamp detail



Installation Instructions

Mounting the control panel

1. Determine mounting location for panel. If distance exceeds the length of either the float switch cables or the pump power cables, splicing will be required. For outdoor or wet installation, we recommend the use of a SJE-Rhombus® liquid-tight junction box with liquid-tight connectors to make required connections. **You must use conduit sealant to prevent moisture or gases from entering the panel.**
2. Mount control panel with mounting flanges furnished with control panel.
3. Determine conduit entrance locations on control panel. Check local codes and schematic for the number of power circuits required.

NOTE: Be sure the incoming power, voltage, amperage, and phase meet the requirements of the pump motors being installed. If in doubt, see the pump identification plate for electrical requirements.

4. Drill proper size holes for type of connectors being used.

NOTE: If using conduit, be sure that it is of adequate size to pull the pump and switch cables through. **You must use conduit sealant to prevent moisture or gases from entering the panel.**

5. Attach cable connectors and/or conduit connectors to control panel.

**FOR INSTALLATION REQUIRING A SPLICE,
FOLLOW STEPS 6-10;
FOR INSTALLATION WITHOUT A SPLICE,
GO TO STEP 11.**

6. Determine location for mounting junction box according to local code requirements. **Do not** mount the junction box inside the sump or basin.

7. Mount junction box to proper support.

8. Run conduit to junction box. Drill proper size holes for the type of conduit used. Attach liquid-tight connectors to junction box.
9. Identify and label each wire before pulling through conduit into control panel and junction box. Pull pump power cables and control switch cables through connectors into junction box. Make wire splice connections at junction box.
10. Firmly tighten and seal all fittings on junction box. Insure all cable connectors are liquid-tight and sealed.
11. If a junction box is not required, connect pump and float wires to proper position on terminals. See schematic inside control panel for terminal layouts.
12. Connect control/alarm and pump power conductors to proper position on terminals. See schematic inside control panel for terminal connections.

NOTE: It is the recommendation of the factory to use separate pump and control/alarm power sources.

**VERIFY CORRECT OPERATION OF CONTROL
PANEL AFTER INSTALLATION
IS COMPLETE.**

Operations

Single phase duplex panels are designed to operate with three or four floats for pump sequencing. The standard float functions are common pump stop, lead pump start, lag pump start/alarm (three floats), or separate lag and alarm floats (four floats).

Three Float Operation: As the liquid level rises to the stop float and tips it to the ON (closed) position, the panel will remain inactive. As the liquid level tips the lead float, the lead pump will start. If the liquid level tips the lag/alarm float, the lag pump will start and the audio/visual alarm will activate. Both pumps and the alarm will remain active until the liquid level drops and the lag float is in the OFF (open) position. At this time the alarm will silence. Both pumps will remain on until the liquid level drops to normal and all three floats are in the OFF (open) position. When both pumps have stopped running, the alternator will switch the lead pump and lag pump operating functions in the next sequence.

Four Float Operation: The alarm will activate and remain on only if the alarm float is tipped to the ON (closed) position.

Alarm System (Horn and Indicator - standard)

When an alarm condition occurs, a red light and a horn will be activated. If the test/normal/silence switch is moved to the silence position, the horn will be silenced. When the alarm condition is cleared, the alarm system is reset. The alarm system can be tested by moving the test/normal/silence switch to the test position.

HOA Switch

A hand-off-automatic switch is provided for each pump. In the hand mode, the pump will turn on unless other safety features are employed. In the automatic mode, the pump will turn on from commands by the float switch(es).

Pump Run Lights

The run light will be ON in either the hand or the automatic mode when the pump is called to run.

Control and Alarm Fusing

The control circuit and alarm circuit are fused separately.

Control and Alarm Lights

Lights will illuminate when control/alarm power is supplied.

Float Status Lights

Lights will illuminate when the respective float is in the closed position.

Circuit Breaker (optional)

The pump circuit has a thermal-magnetic circuit breaker which provides pump disconnect and branch circuit protection.

Dry Auxiliary Contacts (standard feature)

Normally open - Contacts are open under normal conditions and closed when alarm condition is present.

Normally closed - Contacts are closed under normal conditions and open when alarm condition is present. Both types automatically reset once alarm condition is cleared.

NOTE: Some options ordered may not be included in this manual. Certain options will require alternative circuitry not including float status and control/alarm indicators.

For information regarding the operations of options not listed here or servicing questions, please call a Liberty Pumps customer service technician at

1-800-543-2550

Warranty void if panel is modified.

Troubleshooting



WARNING!



ELECTRICAL SHOCK HAZARD

Disconnect all power sources before servicing. Failure to do so could result in serious injury or death.

Control/Alarm Circuit Board Power

If the green power status indicators are not illuminated:

1. Check to see if the fuses on the circuit board are blown.
2. Check to see if the incoming control/alarm power is present at TB1-1 and TB1-2.

If voltage is present and fuse is not blown, please call factory for assistance.

Circuit Breaker (optional)

Check each pole of the circuit breaker for proper resistance reading using the following procedure:

Warning: Disconnect all incoming power to control panel. Failure to do so could result in serious or fatal electrical shock.

1. Isolate the circuit breaker by disconnecting either the line side or load side wires.
2. Place the ohmmeter leads across the corresponding line and load terminals of each pole.
3. With the ohmmeter on the R X 1 scale and the breaker in the OFF position, the reading should be infinity (very high resistance). With the breaker in the ON position, the reading should be nearly zero ohms (very low resistance). If the readings are not as stated, replace the circuit breaker with one of the same ratings.

Alarm Horn

Moving the test/normal/silence switch to the test position or activating the alarm float should turn on the alarm horn. If the horn does not sound, replace horn with same type.

Alarm Light

Moving the test/normal/silence switch to the test position or activating the alarm float should turn on

the alarm light. If the light does not activate, replace with bulb of same type.

Float Controls

Check the floats during their entire range of operation. Clean, adjust, or replace damaged floats.

Checking the float resistance - The float resistance can be measured to determine if the float is operating correctly or is defective. Use the following procedure to measure the float resistance.

Warning: Disconnect all incoming power to panel. Failure to do so could result in serious or fatal electrical shock.

1. Isolate the float by disconnecting one or both of the float leads from the float terminals.
2. Place one ohmmeter lead on one of the float wires, and the other ohmmeter lead on the other float wire.
3. Place the ohmmeter dial to read ohms and place on the R X 1 scale. With the float in the "off" position, the scale should read infinity (high resistance). Replace the float if you do not get this reading. With the float in the ON position, the scale should read nearly zero (very low resistance). Replace the float if you do not get this reading.

NOTE: Readings may vary depending on the length of wire and accuracy of the measuring device.

Fuses

Check the continuity of each fuse. With power OFF, pull the fuses out of the fuse blocks. With the ohmmeter on the R X 1 scale, measure resistance. A reading of infinity indicates a blown fuse and must be replaced. Replace fuse with same type, voltage and amp rating.

Magnetic Contactor Coil

Warning: Disconnect all incoming power to panel. Failure to do so could result in serious or fatal electrical shock. Check the coil by disconnecting one of the coil leads. Measure the coil resistance by setting the ohmmeter on the R X 1 scale. A defective coil will read zero or infinity, indicating a short or opened coil respectively. Replace defective contactor with same type.

Liberty Pumps Three-Year Limited Warranty

***NOTE:** Liberty Pumps, Inc. assumes no responsibility for damage or injury due to disassembly in the field. Disassembly, other than at Liberty Pumps or its authorized service centers, automatically voids warranty.

Liberty Pumps, Inc. warrants that pumps of its manufacture are free from all factory defects in material and workmanship for a period of 3 years from the date of purchase. The date of purchase shall be determined by a dated sales receipt noting the model and serial number of the pump. The dated sales receipt must accompany the returned pump if the date of return is more than 3 years from the "CODE" (date of manufacture) number noted on the pump nameplate.

The manufacturer's obligation under this Warranty shall be limited to the repair or replacement of any parts found by the manufacturer to be defective, provided the part or assembly is returned freight prepaid to the manufacturer or its authorized service center, and provided that none of the following warranty-voiding characteristics are evident.

The manufacturer shall not be liable under this Warranty if the product has not been properly installed; if it has been disassembled, modified, abused or tampered with; if the electrical cord has been cut, damaged or spliced; if the pump discharge has been reduced in size; if the pump has been used in water temperatures above the advertised rating, or water containing sand, lime, cement, gravel or other abrasives; if the product has been used to pump chemicals or hydrocarbons; if a non-submersible motor has been subjected to excessive moisture; or if the label bearing the serial, model and code number has been removed. Liberty Pumps, Inc. shall not be liable for any loss, damage or expenses resulting from installation or use of its products, or for consequential damages, including costs of removal, reinstallation or transportation.

There is no other express warranty. All implied warranties, including those of merchantability and fitness for a particular purpose, are limited to three years from the date of purchase.

This Warranty contains the exclusive remedy of the purchaser, and, where permitted, liability for consequential or incidental damages under any and all warranties are excluded.



7000 Apple Tree Avenue
Bergen, New York 14416
Phone: 1-800-543-2550

Email: liberty@libertypumps.com

www.libertypumps.com

Three Phase Duplex

**AE34=3-131, AE34=3-141, AE34=3-171, AE34=3-191,
AE34=3-511, AE34=4-131, AE34=4-141, AE34=4-171,
AE34=4-191, AE34=5-511, AE54=3-121, and AE54=4-121**

Manufactured by SJE-Rhombus®

Installation Instructions and Operation/Troubleshooting Manual



7000 Apple Tree Avenue
Bergen, New York 14416
Phone: 1-800-543-2550
Email: liberty@libertypumps.com
www.libertypumps.com

This control panel must be installed and serviced by a licensed electrician in accordance with the National Electric Code NFPA-70, state and local electrical codes.

All conduit running from the sump or tank to the control panel must be sealed with conduit sealant to prevent moisture or gases from entering the panel. **NEMA 4X enclosures are for indoor or outdoor use**, primarily to provide a degree of protection against corrosion, windblown dust and rain, splashing water and hose-directed water. **Cable connectors must be liquid-tight in NEMA 4X enclosures.**

⚠ WARNING 	ELECTRICAL SHOCK HAZARD Disconnect power before installing or servicing this product. A qualified service person must install and service this product according to applicable electrical and plumbing codes.	⚠ WARNING 	EXPLOSION OR FIRE HAZARD Do not use this product with flammable liquids Do not install in hazardous locations as defined by National Electrical Code, ANSI/NFPA 70.
Failure to follow these precautions could result in serious injury or death. Replace product immediately if switch cable becomes damaged or severed. Keep these instructions with warranty after installation. This product must be installed in accordance with National Electric Code, ANSI/NFPA 70 so as to prevent moisture from entering or accumulating within boxes, conduit bodies, fittings, float housing, or cable.			

Warranty void if panel is modified.

Call factory with servicing questions:

1-800-543-2550

Installation Instructions

Most three phase duplex panels are designed to operate with three or four float systems. The three float system is standard, performing the common pump stop, lead pump start, and lag pump start/high level alarm functions. The four float system utilizes separate floats for each function.

NOTE: Options ordered may affect the number of floats and their functions. Please reference the schematic provided with the control panel for proper installation.

Installation of Floats

CAUTION: If control switch cables are not wired and mounted in the correct order, the pump system will not function properly.

WARNING: Turn off all power before installing floats in pump chamber. Failure to do so could result in serious or fatal electrical shock.

1. Use float label kit to identify and label cables on both float and stripped ends (stop, lead, lag, alarm, etc.). See schematic for float options.
2. Determine your normal operating level, as illustrated in **Figures 1 & 2**.
3. Mount float switches at appropriate levels as illustrated in **Figures 3-5**. Be sure that floats have free range of motion without touching each other or other equipment in the basin.

If using the mounting clamp; follow steps 4-6.

4. Place the cord into the clamp as shown in **Figure 5**.
5. Locate the clamp at the desired activation level and secure the clamp to the discharge pipe as shown in **Figure 5**.

NOTE: Do not install cord under hose clamp.

6. Tighten the hose clamp using a screwdriver. Over tightening may result in damage to the plastic clamp. Make sure the float cable is not allowed to touch the excess hose clamp band during operation.

NOTE: All hose clamp components are made of 18-8 stainless steel material. See your SJE-Rhombus® supplier for replacements.

FIGURE 1: Three float duplex

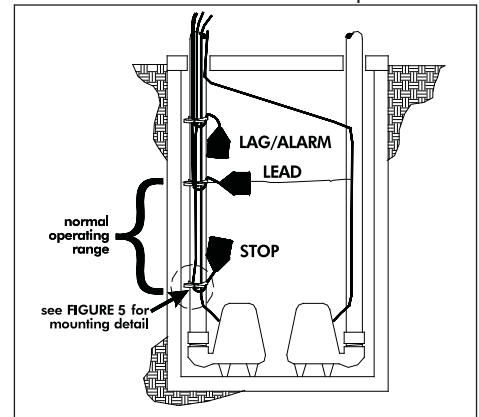

FIGURE 2: Four float duplex

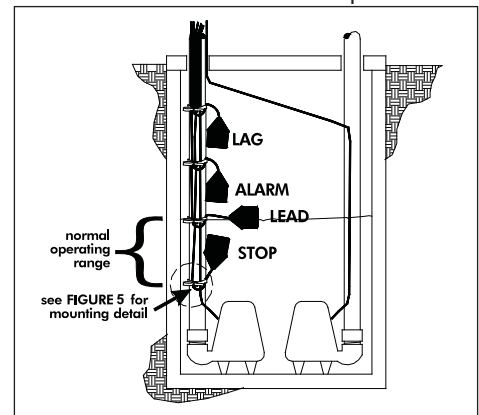

FIGURE 3: Internally weighted float

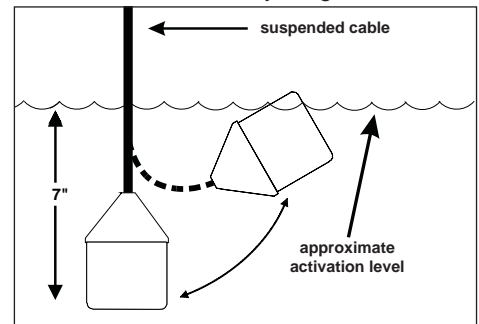

FIGURE 4: Float with cable weight

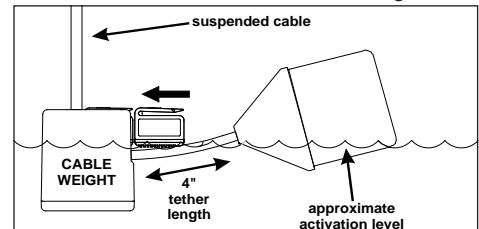
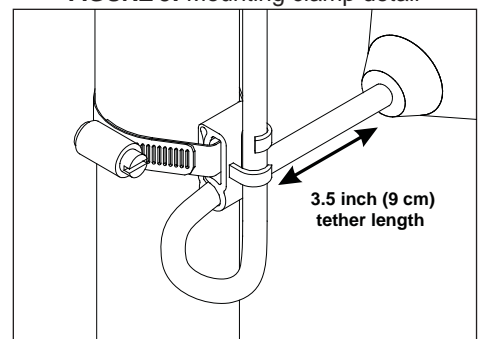

FIGURE 5: Mounting clamp detail



Installation Instructions

Mounting the Control Panel

1. Determine mounting location for panel. If distance exceeds the length of either the float switch cables or the pump power cables, splicing will be required. For outdoor or wet installation, we recommend the use of an SJE-Rhombus® liquid-tight junction box with liquid-tight connectors to make required connections. **You must use conduit sealant to prevent moisture or gases from entering the panel.**
2. Mount control panel with mounting devices furnished.
3. Determine conduit entrance locations on control panel.

NOTE: Be sure the incoming power, voltage, amperage, and phase meet the requirements of the pump motors being installed. If in doubt, see the pump identification plate for electrical requirements.

4. Drill proper size holes for type of connectors being used.
NOTE: If using conduit, be sure that it is of adequate size to pull the pump and switch cables through.
5. Attach cable connectors and/or conduit connectors to control panel.

**FOR INSTALLATION WITHOUT A SPLICE,
GO TO STEP 10; FOR INSTALLATION RE-
QUIRING
A SPLICE, FOLLOW STEPS 6-9.**

6. Determine location for mounting junction box according to state and local code requirements. Mount the junction box to proper support.
7. Run conduit to junction box. Drill proper size holes for the type of conduit used. Attach connectors to junction box.

8. Identify and label each wire before pulling through conduit into control panel and junction box. Make wire splice connections at junction box.
9. Firmly tighten all fittings on junction box.
10. If a junction box is not required, pull cables through conduit into control panel.
11. Set motor protective switches:
 - a) set the dials to match motor full load amps.
 - b) turn dial on motor protective switch to the ON position.

NOTE: Resetting the dial with power applied to the motor protective switch could start the motor.

12. Connect pump wires directly to the motor contactors terminal positions T1, T2, and T3.

NOTE: Three-phase motors will run in either direction. Check pump motor before installation for proper rotation. To correct rotation, change pump cable connections on any two terminals T1-T2-T3.

13. Connect “power-in” conductors to proper locations: 208/240/480 VAC on the 3 position terminal block. **Install tagged factory wire to appropriate transformer primary voltage tap.**

**VERIFY CORRECT OPERATION
OF CONTROL PANEL AFTER
INSTALLATION IS COMPLETE.**

Operations

Three phase duplex panels are designed to operate with three or four floats for pump sequencing. The standard float functions are common pump stop, lead pump start, lag pump start/alarm (three floats), or separate lag and alarm floats (four floats). Other float options, such as redundant off, are available.

Three Float Operation: As the liquid level passes the stop float and tips it to the ON (closed) position, the panel will remain inactive. As the liquid level tips the lead float, the lead pump will start. If the liquid level tips the lag/alarm float, the lag pump will start and the audio/visual alarm will activate. Both pumps and the alarm will remain active until the liquid level drops and the lag float is in the OFF (open) position. At this time the alarm will silence. Both pumps will remain on until the liquid level drops to normal and all three floats are in the OFF (open) position. When both pumps have stopped running, the alternator will switch the lead pump and lag pump operating functions in the next sequence.

Four Float Operation: The alarm will activate and remain on only if the alarm float is tipped to the ON (closed) position.

Alarm System (Horn and Indicator)

When an alarm condition occurs, a red light and a horn will be activated. If the test/normal/silence switch is moved to the silence position, the horn will be silenced. When the alarm condition is cleared, the alarm system is reset. The alarm system can be tested by moving the test/normal/silence switch to the test position.

Control/Alarm Switch

Allows the control/alarm power to be turned on or off.

HOA Switch

A hand-off-automatic switch is provided for each pump. In the hand mode, the pump will turn on unless other safety features are employed. In the automatic mode, the pump will turn on from commands by the float switches.

Motor Protective Switch

A motor protective switch is supplied for each pump to provide an adjustable overload, branch circuit protection and disconnect. The overload must be set in the field. To set the overload, dial the amp scale to the pump's full load amp rating (FLA). If the FLA's are unknown, use a calibrated amp meter to measure the pump amperage draw under loaded conditions. An auxiliary contact is

wired in series with the magnetic contactor coil so that on an overload trip, the magnetic contactor will be disabled. In the event of an overload trip, the motor protective switch must be reset by first turning the selector handle counterclockwise to the OFF position and then turning the handle 90° clockwise to the ON position.

Control/Alarm Light

The light will illuminate when the control ON/OFF switch is in the ON position.

Pump Run Lights

Each pump has a run light. The run light will be ON in either the hand or the automatic mode when the pump is called to run.

Float Status Lights

Lights will illuminate when the respective float is in the closed position.

Dry Auxiliary Contacts (optional)

Normally open - Contacts are open under normal conditions and closed when alarm condition is present.

Normally closed - Contacts are closed under normal conditions and open when alarm condition is present.

Both types automatically reset once alarm condition is cleared.

Seal Failure Circuit and Indicator Light (optional)

The seal fail circuit has resistance sensitivity and will sense the presence of water in the pump seal chamber. Upon installation, turn the sensitivity dial on the seal fail module to the point where the light turns on, then dial back slowly until the light turns off. If water enters the seal chamber at this point, the seal fail circuit will sense the change in resistance. After a short time delay, the indicator light will turn on. When the condition is cleared, the relay will de-energize and the indicator light will turn off. The seal fail relay has a sensitivity adjustment so that false readings may be tuned out.

Thermal Cutout (optional)

The thermal cutout is wired in series with the magnetic contactor coil. If the pump's thermal switch opens on high temperature, the contactor will turn off and stop the pump. When the thermal switch cools and closes, the magnetic contactor will turn on if the pump is called to run.

NOTE: Some options ordered may not be included in this manual.

Troubleshooting



Alarm Horn

Pressing the alarm test/normal/silence switch to the test position or activating the alarm float should turn on the alarm horn. If the horn does not sound, replace with horn of same type.

Alarm Light

Pressing the alarm test/normal/silence switch to the test position or activating the alarm float should turn on the alarm light. If the light does not activate, replace with bulb of same type.

Alternating Relay or Device

The alternation can be sequenced by lifting the float switches or making jumper wires to simulate the floats closing. If the alternator fails during testing, replace with same type. Consult factory at **1-800-RHOMBUS** (1-800-746-6287) when in doubt about testing procedures or results.

Float Controls

Check the floats through their entire range of operation. Clean, adjust, or replace damaged floats.

Checking the float resistance - The float resistance can be measured to determine if the float is operating correctly or is defective. Use the following procedure to measure the float resistance:

1. Isolate the float by disconnecting one or both of the float leads from the float terminals.
2. Place one ohmmeter lead on one of the float wires, and the other ohmmeter lead on the other float wire.

3. Place the ohmmeter dial to read ohms and place on the R X 1 scale. With the float in the "off" position, the scale should read infinity (high resistance). Replace the float if you do not get this reading. With the float in the ON position, the scale should read nearly zero (very low resistance). Replace the float if you do not get this reading.

NOTE: Readings may vary depending on the length of wire and accuracy of the measuring device.

Fuses

Check the continuity of the fuse. Pull the fuse out of the fuse block. With the ohmmeter on the R X 1 scale, measure resistance. A reading of infinity indicates a blown fuse and must be replaced. Replace fuse with same type, voltage and amp rating.

Magnetic Contactor

Contacts - Check the contacts for severely burnt or welded contacts. The contactor arm should move freely.

Coil - Measure the coil by disconnecting one of the coil leads. Measure the coil resistance by setting the ohmmeter on the R X 1 scale. A defective coil will read zero or infinity, indicating a short or opened coil respectively. If contactor is defective, replace with same type.

NOTE: Readings may vary slightly depending on the and accuracy of the measuring device.

Motor Protective Switch

Test by inserting a paper clip or other small device into the test hole and push to the left. The relay should trip.

Liberty Pumps Three-Year Limited Warranty

***NOTE:** Liberty Pumps, Inc. assumes no responsibility for damage or injury due to disassembly in the field. Disassembly, other than at Liberty Pumps or its authorized service centers, automatically voids warranty.

Liberty Pumps, Inc. warrants that pumps of its manufacture are free from all factory defects in material and workmanship for a period of 3 years from the date of purchase. The date of purchase shall be determined by a dated sales receipt noting the model and serial number of the pump. The dated sales receipt must accompany the returned pump if the date of return is more than 3 years from the "CODE" (date of manufacture) number noted on the pump nameplate.

The manufacturer's obligation under this Warranty shall be limited to the repair or replacement of any parts found by the manufacturer to be defective, provided the part or assembly is returned freight prepaid to the manufacturer or its authorized service center, and provided that none of the following warranty-voiding characteristics are evident.

The manufacturer shall not be liable under this Warranty if the product has not been properly installed; if it has been disassembled, modified, abused or tampered with; if the electrical cord has been cut, damaged or spliced; if the pump discharge has been reduced in size; if the pump has been used in water temperatures above the advertised rating, or water containing sand, lime, cement, gravel or other abrasives; if the product has been used to pump chemicals or hydrocarbons; if a non-submersible motor has been subjected to excessive moisture; or if the label bearing the serial, model and code number has been removed. Liberty Pumps, Inc. shall not be liable for any loss, damage or expenses resulting from installation or use of its products, or for consequential damages, including costs of removal, reinstallation or transportation.

There is no other express warranty. All implied warranties, including those of merchantability and fitness for a particular purpose, are limited to three years from the date of purchase.

This Warranty contains the exclusive remedy of the purchaser, and, where permitted, liability for consequential or incidental damages under any and all warranties are excluded.



7000 Apple Tree Avenue
Bergen, New York 14416
Phone: 1-800-543-2550

Email: liberty@libertypumps.com

www.libertypumps.com