

Features

- Includes face plate with handle.
- Single handle controls both on/off activation and temperature settings.
- Supplied with ADA compliant metal lever handle.
- Complements Purist faucets and accessories.

Material

- Premium material construction with metal handle ensures reliability and durability.
- KOHLER finishes resist corrosion and tarnishing.

Installation

- Trim only; requires valve to complete installation (sold separately).

Required Products/Accessories

- K-2971-KS 3/4" Pressure-balancing Valve
- or
- K-304-CS Pressure-balancing Valve With Stops
- or
- K-304-CX Pressure-balancing Valve Less Stops
- or
- K-304-K Pressure-balancing Valve Less Stops
- or
- K-304-KS Pressure-balancing Valve With Stops
- or
- K-304-PS Pressure-balancing Valve With Stops
- or
- K-304-PX Pressure-balancing Valve Less Steps
- or
- K-304-US Pressure-balancing Valve With Stops
- or
- K-304-UX Pressure-balancing Valve Less Stops
- or
- K-P304-CS Pressure-balancing Valve With Stops
- or
- K-P304-CX Pressure-balancing Valve Less Stops
- or
- K-P304-K Pressure-balancing Valve Less Stops
- or
- K-P304-KS Pressure-balancing Valve With Stops
- or
- K-P304-PS Pressure-balancing Valve With Stops
- or
- K-P304-PX Pressure-balancing Valve Less Stops
- or
- K-P304-UX Pressure-balancing Valve Less Stops
- or
- K-P304-US Pressure-balancing Valve With Stops
- or
- K-8304-K Valve Body & Cartridge Kit Complete



ADA **CSA B651** **OBC**

Codes/Standards









ASME A112.18.1/CSA B125.1
ADA
ICC/ANSI A117.1
CSA B651
OBC

KOHLER® Faucet Lifetime Limited Warranty

See website for detailed warranty information.

Available Colors/Finishes

Color tiles intended for reference only.

Color	Code	Description
	CP	Polished Chrome
	SN	Vibrant® Polished Nickel
	BGD	Vibrant® Moderne Brushed Gold
	BN	Vibrant® Brushed Nickel
	BV	Vibrant® Brushed Bronze
	BL	Matte Black
	2MB	Vibrant® Brushed Moderne Brass
	RGD	Vibrant Rose Gold
	VHR	

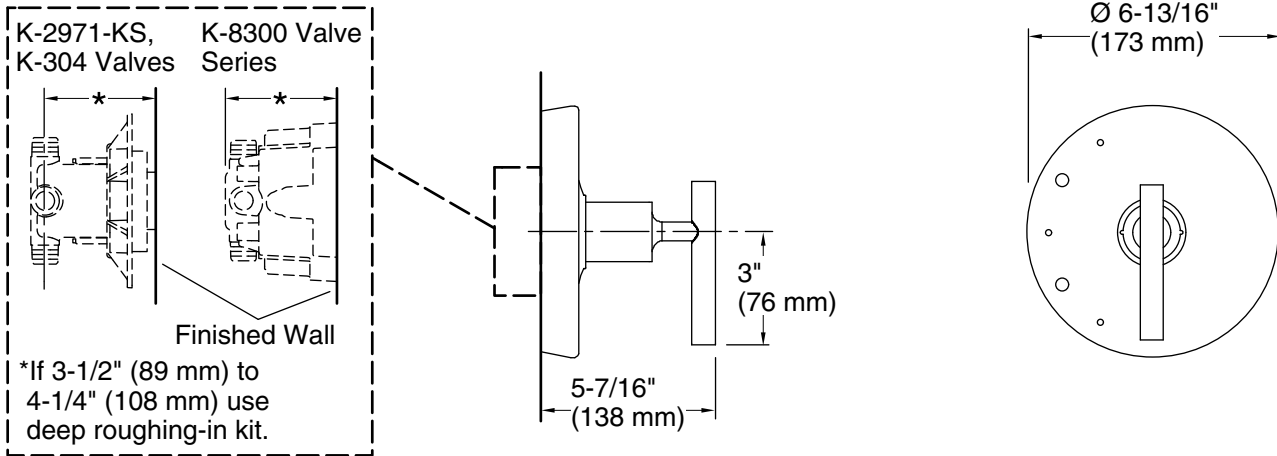

Technical Information

All product dimensions are nominal.

Notes

Install the product according to the installation guide.

NOTICE: Risk of product damage. Long screws for installing trim can damage the K-2971-KS valve. Consult the trim installation guide to verify if the thin wall installation kit (88526) is needed.

ADA, OBC, CSA B651 compliant when installed to the specific requirements of these regulations.