

## AutoFill™ Automatic filling valve

### 5350 Series

### Installation, commissioning and servicing instructions



#### Function

The 5350 series AutoFill™ automatic filling valve is a pressure reducing valve which when installed on the water inlet piping in closed hydronic systems will maintain system pressure at a set value, automatically filling up with water as required. Fast fills the system to set pressure then automatically shuts off the water feed. This product is factory pre-set to 15 psi system pressure. To adjust the set pressure, simply turn the adjustment knob while observing the integral downstream pressure gauge. **This product has the characteristic of being pre-adjustable, which means that it can be adjusted at the right pressure value before the system charging phase.** After installation, the system pressure will automatically adjust itself to the set value and the water feed will stop when the set pressure is reached. The internal cartridge containing all the controlling components is pre-assembled as a self-contained unit, to facilitate inspection and maintenance procedures.

#### Product range

5350 Series AutoFill Automatic filling valve with pressure gauge and pressure setting adjustment knob with NPT, Press, and Sweat connections, size 3/4".

#### Technical Characteristics

· Materials:	-Body:	brass
	-Cover:	Glass fiber reinforced nylon PA66G30
	-Control spindle:	stainless steel
	-Moving parts:	brass
	-Diaphragm & seals:	NBR
	-Filter:	stainless steel
· Max working pressure:		365 psi (25 bar)
· Downstream pressure setting range:		6–90 psi (0.5–6 bar)
· Factory setting:		15 psi (1.035 bar)
· Max. working temperature:		140°F (0–60°C)
· Pressure gauge scale:		0–100 psi (0–7bar)
· Filter mesh size:		0.51 mm (35 mesh)
- Environmental:		indoor only
· Suitable fluids:		water
· Connections:	-NPT male union:	3/4"
	-Sweat union:	3/4"
	-Press:	3/4"
	-Lay length (press connection):	4-7/16"
	-Pressure gauge:	1/8" NPT

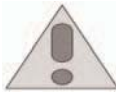

## SAFETY INSTRUCTION

This safety alert symbol will be used in this manual to draw attention to safety related instructions. When used, the safety alert symbol means **ATTENTION! BECOME ALERT! YOUR SAFETY IS INVOLVED! FAILURE TO FOLLOW THESE INSTRUCTIONS MAY RESULT IN A SAFETY HAZARD.**

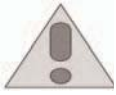

**CAUTION:** All work must be performed by qualified personnel trained in the proper application, installation, and maintenance of systems in accordance with all applicable codes and ordinances.

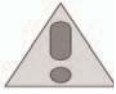

**CAUTION:** If the automatic filling unit is not installed, commissioned and maintained properly, according to the instructions contained in this manual, it may not operate correctly and may endanger the user.

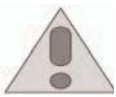

**CAUTION:** Make sure that all the connecting pipework is water tight.



**CAUTION:** When making the water connections, make sure that the unit connecting pipework is not mechanically overstressed. Over time this could cause breakages, with consequent water losses which, in turn, could cause harm to property and/or people.

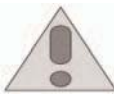

**CAUTION:** Water temperatures higher than 100°F (38°C) can be dangerous. During the installation, commissioning and maintenance of the automatic filling valve, take the necessary precautions to ensure that such temperatures do not endanger people.

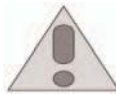

**CAUTION:** In the case of highly aggressive water, arrangements must be made to treat the water before it enters the unit, in accordance with current legislation. Otherwise the unit may be damaged and will not operate correctly.

**Leave this manual for the user.**

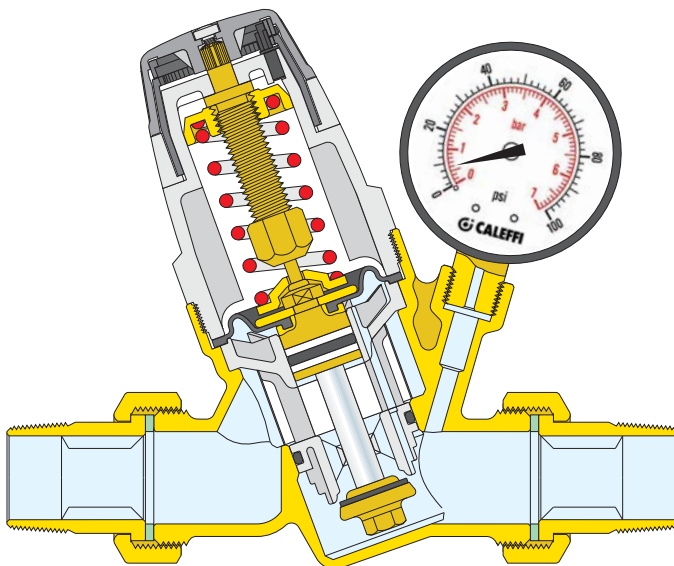

### Pre-adjustment

AutoFill automatic filling valves in the 5350 series come standard with an operating adjustment knob and an integral downstream outlet pressure gauge. This adjustment knob features rotational operation. The pressure can be adjusted continuously, resulting in 7 psi per revolution, with the value displayed on the outlet gauge.

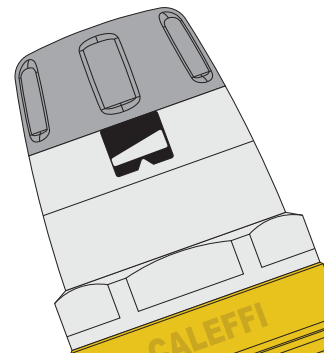

## Removable self-contained cartridge

The cartridge, containing the diaphragm, strainer, seat, valve port and compensating piston, is pre-assembled as a “self-contained unit” with a cover and can be easily removed for inspection and maintenance procedures.

### Installation

1. Filling valve can be installed in either horizontal or vertical position. Do not install upside down. Do not install outdoors.
2. Caleffi recommends the AutoFill 5350 series filling valve be installed with separately-purchased shutoff ball valves, code NA39589, upstream and downstream.
3. The AutoFill 5350 series filling valve does not have an internal check valve to prevent reverse flow of water. For this reason, a backflow preventer installed upstream is recommended. Use a Caleffi code 573503A, or other brand that complies with applicable codes.
4. The system pressure is factory pre-set to 15 psi (1.035 bar).

**a. To properly reset to a higher desired system pressure (greater than 15 psi),** start by opening the inlet shutoff valve while keeping the outlet shutoff valve closed. Adjust the operating knob clockwise (+) to increase the system pressure to the desired value as indicated on the outlet gauge, approximately 7 psi per revolution.

**b. To reset to a lower system (lower than 15 psi),** turn the operating knob counterclockwise (-) until it stops turning, 0 psi. Then, open the inlet shutoff valve while keeping the outlet shutoff valve closed. Adjust the operating knob clockwise (+) to increase the system pressure to the desired value as indicated on the outlet gauge, approximately 7 psi per revolution.

5. When the desired system pressure is indicated on the gauge, slowly open the outlet shutoff valve, filling the system.
6. During the filling, in fast-fill mode, the valve will automatically control the system pressure until it reaches the desired value, without the need to monitor the filling operation itself. After installation, the internal mechanism will automatically control system pressure to the desired value.

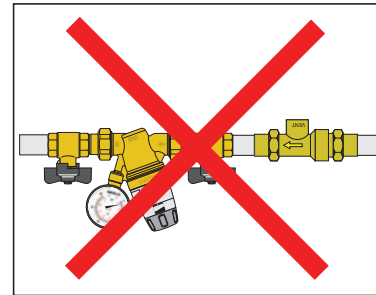
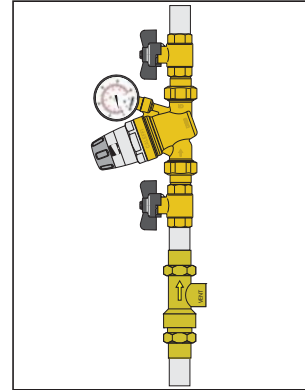
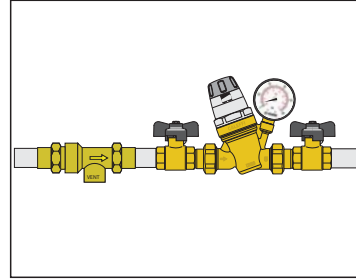

### Maintenance

When checking, cleaning or replacing the complete regulating cartridge:

1. Isolate the filling valve.
2. The special construction of the filling unit does not require any adjustment of the system pressure, which can be left at the set value.
3. Remove the upper cover. The upper cover is integral with the internal regulating cartridge.
4. Check and clean the filter.
5. When the cartridge is screwed back into the body, the pressure setting will return to the original value.
6. Reopen the shut-off valves. The pressure will return to the original set value.

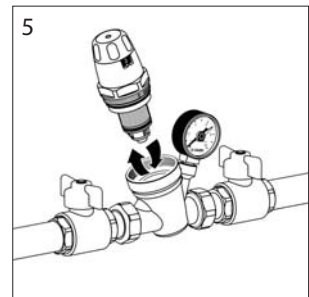
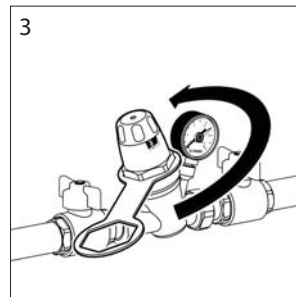

# Application diagram

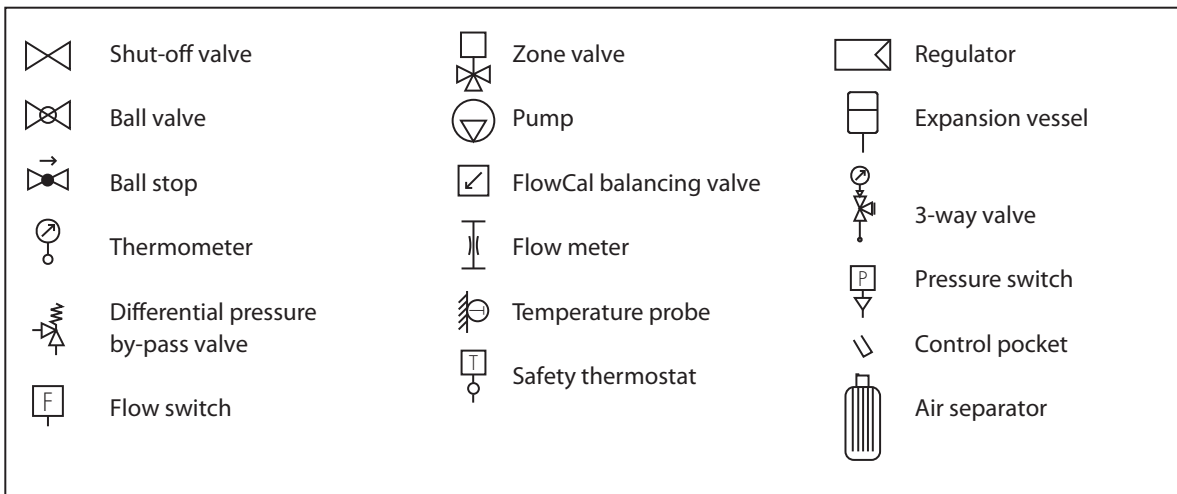
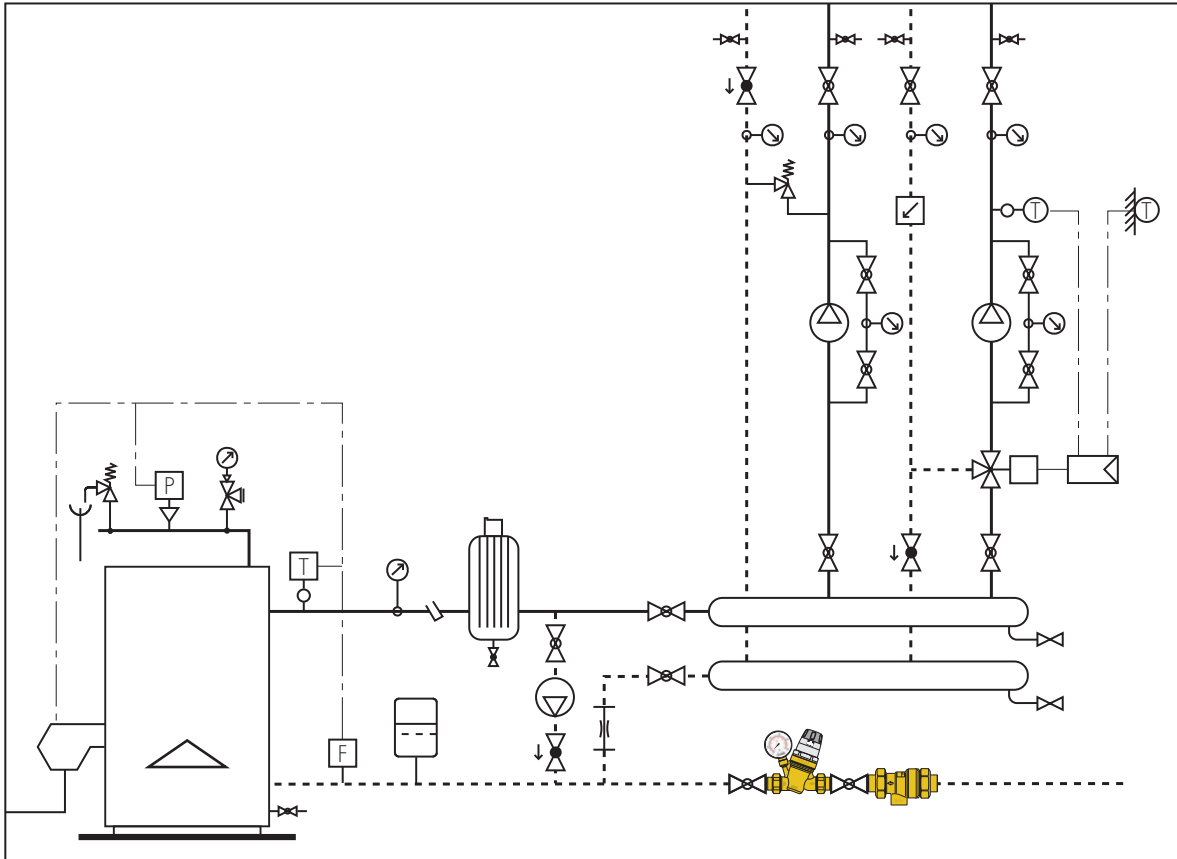

Caleffi North America, Inc.  
 3883 W. Milwaukee Road  
 Milwaukee, WI 53208  
 T: 414.238.2360 F: 414.238.2366